



Natare Hydrotherapy Pools, Spas and Whirlpools

Information and Technical Data



Natare Corporation
5905 West 74th Street • Indianapolis, IN 46278 • USA
(800) 336-8828 • (317) 290-8828 • FAX (317) 290-9998
www.natare.com • natare@natare.com



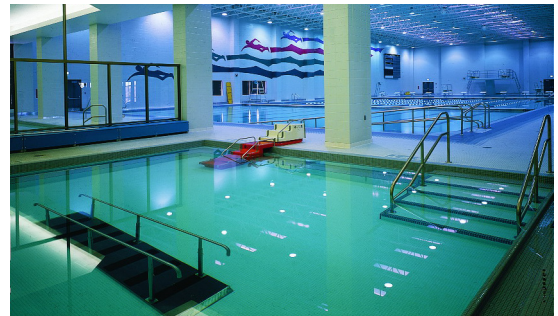

Table of Contents

- I. Typical Drawings and Details**
- II. Sample Warranty**



All information contained in this booklet, as well as information on other Natare products and systems, is available by download from www.natare.com, available by email at natare@natare.com, or on a CD upon request: (800) 336-8828.



The information in this document is proprietary, confidential and is the exclusive property of Natare Corporation. These materials are not considered published and are provided for the exclusive use of the intended recipient for the intended use in conjunction with equipment, systems or services provided by Natare, and they may be copied or distributed to third parties for that purpose. Natare, Uniwall and the stylized N are trademarks of the Natare Corporation. © Copyright 1997-2008 Natare Corporation. All rights reserved.



Natare's Uniwall® Whirlpools, Spas and Hydrotherapy Pools are pre-engineered pools custom-designed and tailor-made to fit the unique and individual needs of your hospital, clinic, health club, and even therapeutic facilities designed for physically challenged senior citizens.

The Uniwall pool construction system consists of a structural wall system fabricated from tough, durable stainless steel that is ideal for hospitals, clinics, and therapeutic situations that require a whirlpool or spa that will not crack, deteriorate or leak but still aesthetically pleasing to the eye with hygienic qualities, a low-maintenance program and a virtually unlimited lifespan.

Uniwall Stainless Steel Spas or Hydrotherapy Pools are available in prefabricated or custom-fabricated units. The unique construction system of Uniwall makes Natare whirlpools, spas, and hydrotherapy pools ideal for a variety of situations including in ground, freestanding and elevated pools.

Parallel bars, access ramps, padded floor surfaces, resistance jet units and even underwater treadmills can be incorporated into your hydrotherapy pool making it possible to meet a variety of facilitative needs.

Other available options include, but are not limited to, terraced depths, temperature modulation, submerged walking tracks, underwater viewing/video windows, and counter-swim systems.

Design a cost-effective and easily maintained mechanical system by insisting on Natare's recirculation, disinfection, filtration and heating systems, whether as a totally automatic system or with simple manual operation.



Spa with Skimmers

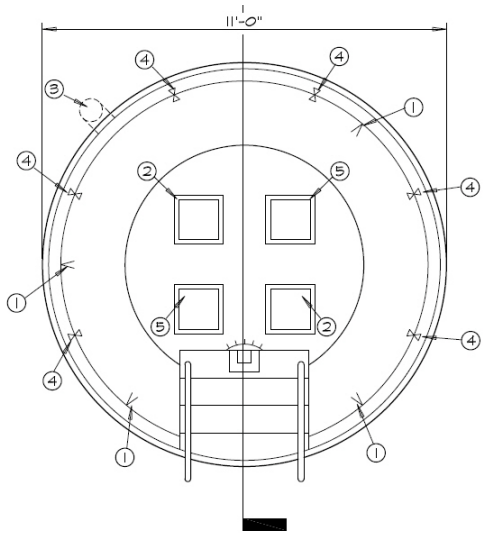

WHIRLPOOL PLAN VIEW
 SCALE: 3/8" = 1'-0"

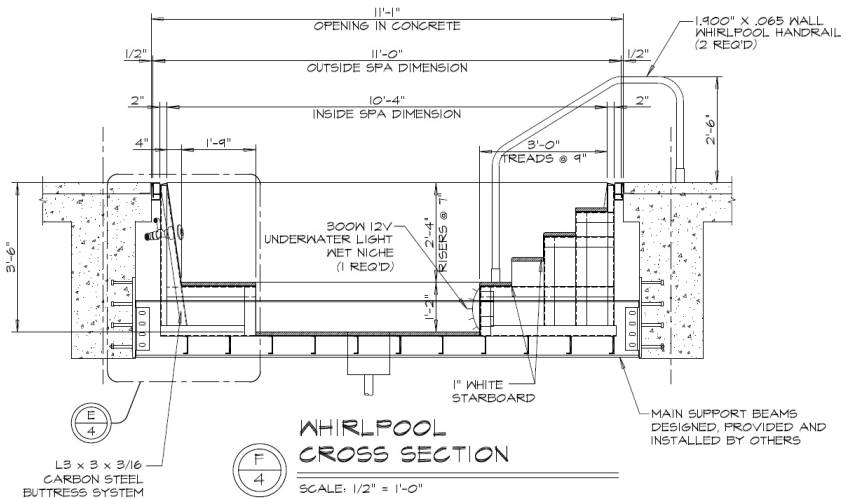

WHIRLPOOL CROSS SECTION
 SCALE: 1/2" = 1'-0"

Spa with Gutter

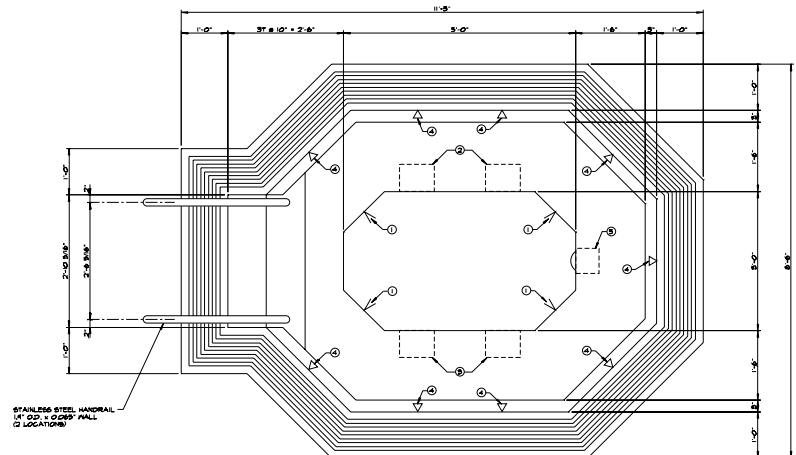

STAINLESS STEEL HANDRAIL
 1" O.D. x 0.065" WALL
 (2 REQ'D)

ITEM	QUANTITY	DESCRIPTION
1	4	INLET FITTINGS 1/2" WALL TYPE DIRECTIONAL
2	2	MAIN DRAIN SUCTION BOX 24" x 12"
3	2	HYDROTHERAPY SECTION BOX 24" x 12"
4	4	HYDROTHERAPY INLETS AIR INTAKE CONNECTIONS
5	1	UNDERWATER LIGHT 100W 120 VOLT

Spa and Whirlpool Typical

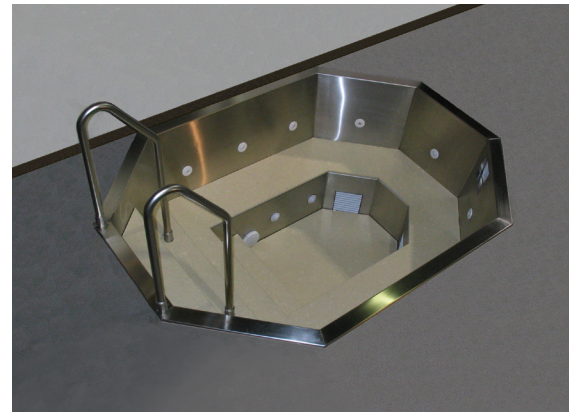
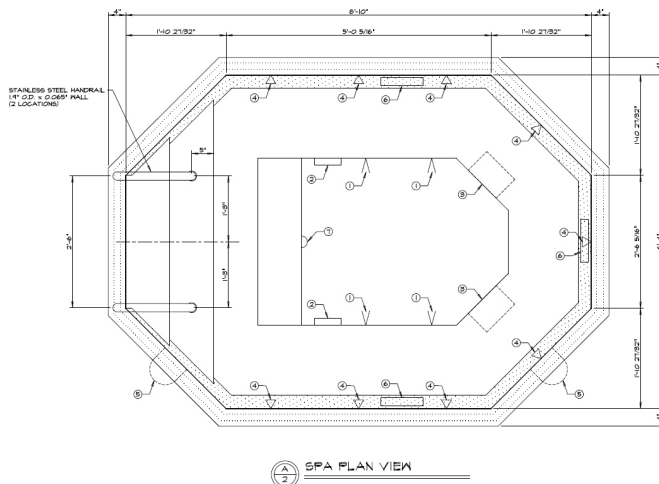
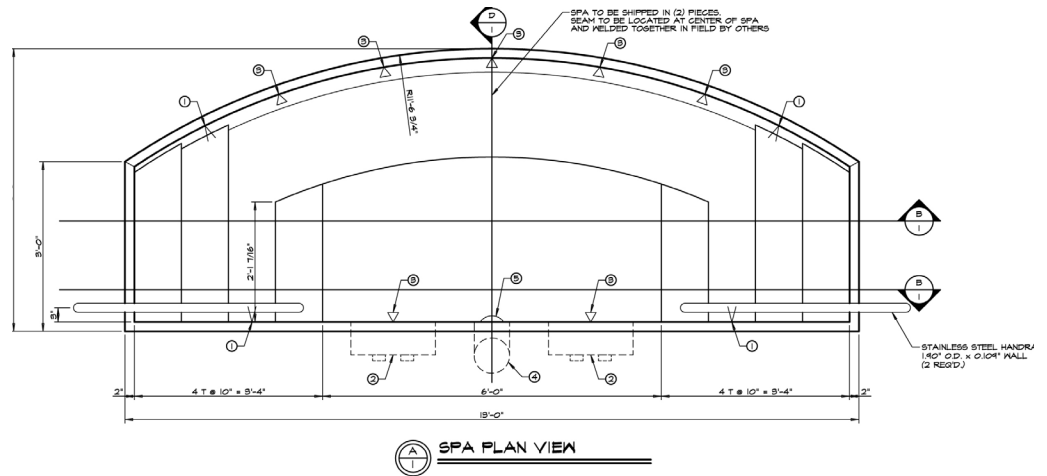
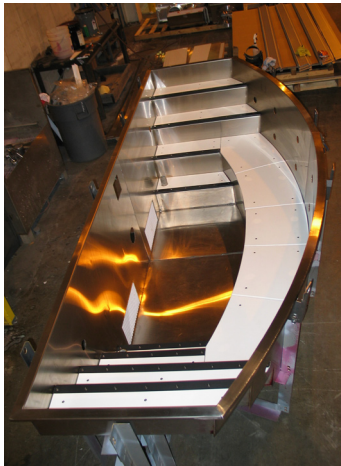

Standard and Optional Items for Nature's Uniwall Spas and Whirlpools

Item	Standards	Optional
Shell Material	Type 304L stainless steel	Type 316L stainless steel
Material Thickness	12 gauge material	10 gauge material or as desired
Support Structure	A 36 coated carbon steel	Stainless steel
Interior Finishes	# 3 polished stainless steel	Synthetic solid surfacing, tile, natural stone or PVC Membrane
Drains, Outlets & Inlets	Main and hydrotherapy drains, supply inlets and skimmers	Seat bubbler, counter swim jet, Perimeter gutter, vacuum filter or as desired
Plumbing	Not included	Factory plumbed with flex or rigid PVC piping
Hand Rail		Stainless steel
Underwater Lighting		Small, high intensity
Other features include foam insulation, sectional or knock-down construction.		



Information and Technical Data
Uniwall® Hydrotherapy Pool and Spa Systems

Rehabilitation Pool Typical

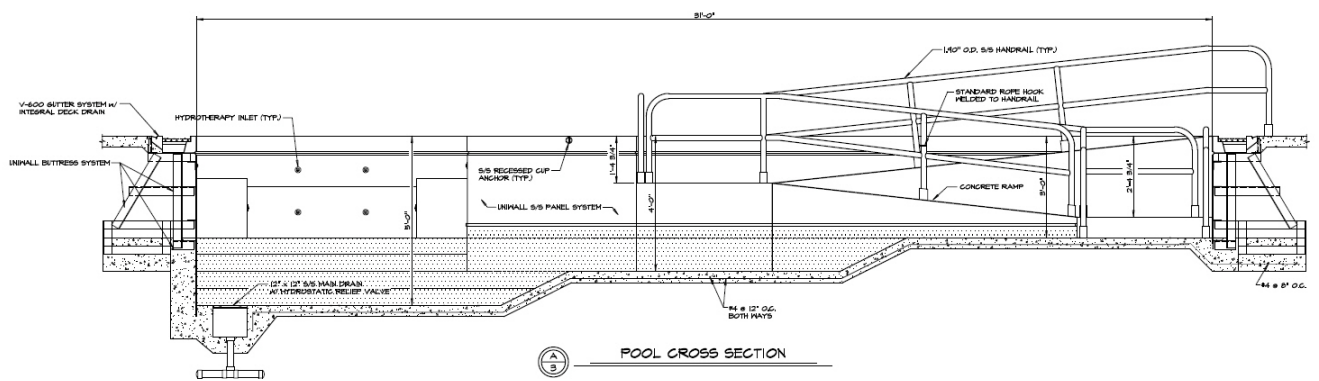
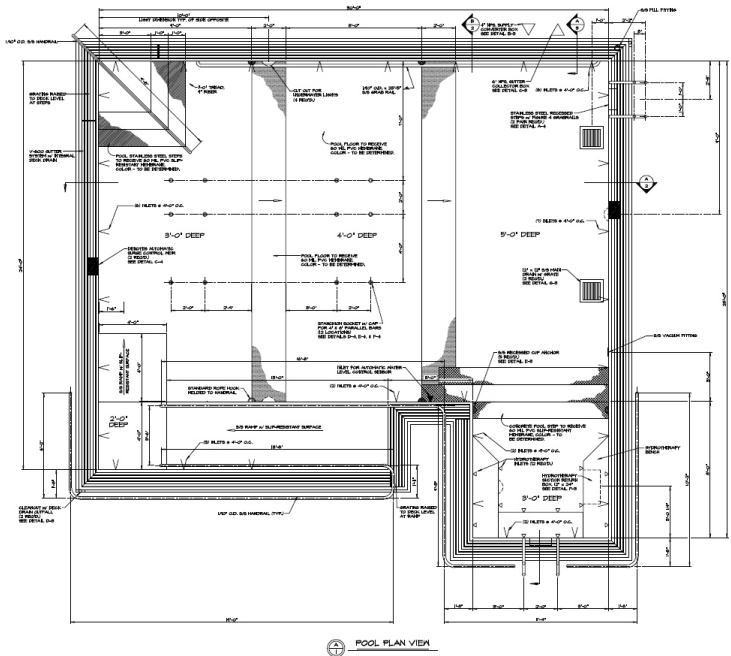
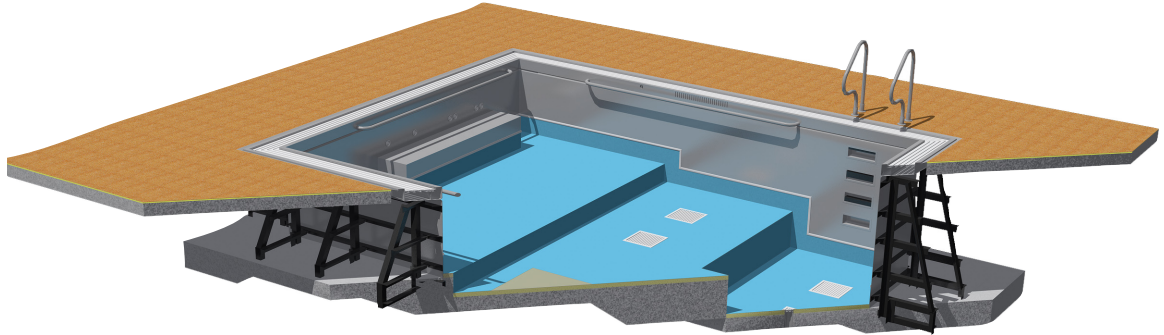



Sample Warranty

SAMPLE
STATEMENT OF WARRANTY
Uniwall® Stainless Steel Elevated Swimming Pool System

NATARE CORPORATION (“Natare”) hereby provides to _____ (“Owner”) the warranties contained herein, or on exhibit on hereto, regarding the Uniwall™ Stainless Steel Elevated Pool System manufactured by Natare and installed at _____ (“project”):

Natare WARRANTS that the Uniwall™ Stainless Steel Elevated Pool System is comprised of new materials, was constructed in a workmanlike manner, and was constructed in accordance with Natare’ drawings, submittals, and technical details. Natare further WARRANTS that, commencing upon the completion of the installation, the Uniwall™ Stainless Steel In-Elevated System shall be free from defects in materials and workmanship and shall perform in a proper and workmanlike manner under normal use and service for a period of ____ years.

In the event that during the warranty period the Uniwall™ Stainless Steel Elevated Pool System shall fail to perform as stated herein, Natare agrees that it shall, as soon as practical after receipt of written notice from the owner, and at its option, either repair or replace the defective part or parts of the system, or refund to the Owner the portion of the purchase price attributable to the defective part or parts of the system.

Specifically exempted from these warranties are claims arising from: abuse or other conditions exceeding normal use; improper or incorrect operation, or maintenance; or any use of the product other than the particular use for which the product was intended; and structural or earth movements; or acts of God.

The warranty described herein is provided solely with regard to the Uniwall™ Stainless Steel Elevated Pool System purchased from Natare undamaged prior to installation and which has been paid for in full. In no event shall Natare be liable for any consequential damage, loss, or expense arising in connection with the use or inability to use the Uniwall™ Stainless Steel Elevated Pool System for any purpose whatsoever. Goods or equipment not manufactured by Natare are covered only by the standard warranty of the manufacturer, though sold or operated with Natare’ goods or equipment.

As to work or labor performed by Natare, Natare represents that such is done in a reasonable and workable manner. Should any repair be required within the warranty period for deficient workmanship by Natare, Natare will undertake the required repair, and such repair or the cost thereof, shall be exclusive entitlement of the owner for any defective workmanship. Any claims against Natare must be made promptly in detail and in writing. All Natare’ warranties and other duties with respect to material, equipment, systems, or services furnished by Natare shall be conclusively presumed to have been satisfied one day after the expiration of the warranty period as set forth herein:

In no event shall Natare Corporation be liable for any consequential or other damages whatsoever, direct or indirect, except as expressly agreed to by Natare in writing. There are no other warranties or guaranties, expressed or implied, given by Natare or its agents except those provided herein.



NATARE CORPORATION
5905 West 74th Street
Indianapolis, IN 46278
(317) 290-8828

EFFECTIVE DATE OF WARRANTY _____

SIGNED BY _____



Natare Corporation
5905 West 74th Street • Indianapolis, IN 46278 • USA
(800) 336-8828 • (317) 290-8828 • FAX (317) 290-9998
www.natare.com • natare@natare.com



The information in this document is proprietary, confidential and is the exclusive property of Natare Corporation. These materials are not considered published and are provided for the exclusive use of the intended recipient for the intended use in conjunction with equipment, systems or services provided by Natare, and they may be copied or distributed to third parties for that purpose. Natare, the stylized N, Uniwall, NataClad, MicroFlo, MicroCell, NataDek, SoftDek, and Natatec are trademarks of the Natare Corporation. © Copyright 1997-2008 Natare Corporation. All rights reserved. - Hydrotherapy ITD Book 9/2008